

MSFC 系列 | 32A 塑料防爆插头插座 |

MSFC series 32A Ex-proof plastic socket & plug

▶ 应用场合 Application

1 区、2 区爆炸性气体和 21 区、22 区可燃性粉尘易爆区域

Application: Suitable for zone 1 and zone 2 under potentially explosive atmospheres, zone 21 and zone 22 under dust potentially explosive situations

防爆标志 : Ex de IIC T6 Gb Ex tD A21 IP66 T80 °C

Ex mark : Ex de IIC T6 Gb Ex tD A21 IP66 T80 °C

适用环境温度 : -20°C - +40 °C

Permissible ambient temperature : -20°C - +40 °C

额定电压 : 可至 690 V

Rated voltage : Up to 690V

额定电流 : 32A

Rated current: 32A

防护等级 : IP66

Degree of protection: IP66



壁式插座 Wall socket

进线开孔 : M40x1.5

Cable entrance : M40x1.5

电缆接入 : ϕ 17-28mm

Cable gland : ϕ 17-28mm

接线端子 : 2x4-10 mm²

Connecting terminals : 2x4-10mm²

壳体材质 : 玻璃纤维增强聚酯

Enclosure material : glass-fibre reinforced polyester

插头 Plug

电缆接入 : ϕ 17-28mm

Cable gland : ϕ 17-28mm

接线端子 : 1.0-6mm²

Connecting terminals : 1.0-6 mm²

壳体材质 : 聚酰胺

Enclosure material : polyester

法兰插座 Flange socket

接线端子 : 2x4-10mm²

Connecting terminals : 2x4-10mm²



























壳体材质 : 聚酰胺

Enclosure material : polyester

MSFC 系列 | 32A-4P 塑料防爆插头插座 |

MSFC series 32A-4P Ex-proof plastic socket & plug

▶ Ex-plug & socket suitable for zone1 ,zone2 & zone 21 ,zone 22

类别 Type	时钟位置 h	电压 Voltage	颜色 Colour	重量 Weight	订货号 Order No.
壁式插座 Wall Socket 	 9h	200-250 V		1.8 kg	MSFC032149
	 6h	380-415 V		1.8 kg	MSFC032146
	 7h	480-500 V		1.9 kg	MSFC032147
	 5h	600-690 V		1.9 kg	MSFC032145
法兰插座 Flange Socket 	 9h	200-250 V		1.0 kg	MSFC032249
	 6h	380-415 V		1.0 kg	MSFC032246
	 7h	480-500 V		1.0 kg	MSFC032247
	 5h	600-690 V		1.0 kg	MSFC032245
插头 Plug 	 9h	200-250 V		0.7kg	MSFC032349
	 6h	380-415 V		0.7kg	MSFC032346
	 7h	480-500 V		0.7kg	MSFC032347
	 5h	600-690 V		0.7kg	MSFC032345



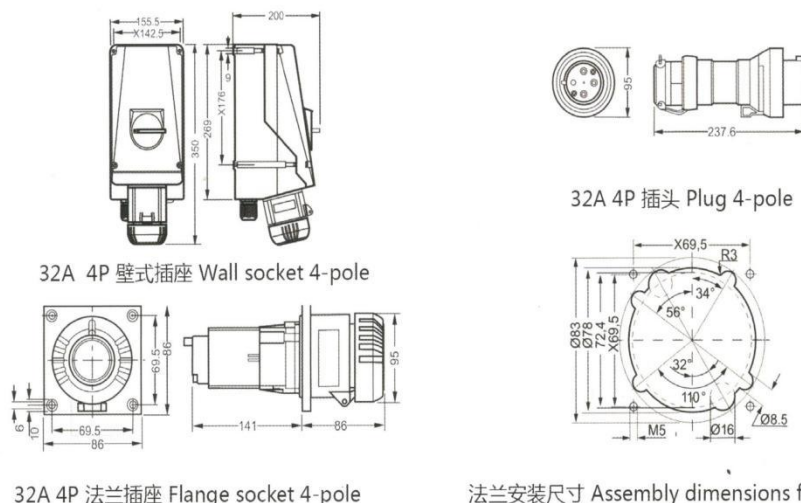





▶ 外形尺寸 Outline dimension



MSFC 系列 | 32A-5P 塑料防爆插头插座 |

MSFC series 32A-5P Ex-proof plastic socket & plug

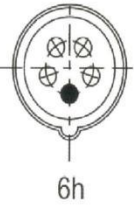
▶ Ex-plug & socket suitable for zone1 ,zone2 & zone 21 ,zone 22

类别 Type	时钟位置 h	电压 Voltage	颜色 Colour	重量 Weight	订货号 Order No.
壁式插座 Wall Socket 		200-250 V 380-415 V		1.9kg	MSFC032156
法兰插座 Flange Socket 		200-250 V 380-415 V		1.0kg	MSFC032256
插头 Plug 		200-250 V 380-415 V		0.7kg	MSFC032356

▶ 外形尺寸 Outline dimension

